

Landkreis Unterallgäu  
Kreisbrandinspektion

Fachbereich  
EDV, Funk und  
Kommunikation



# Fortbildungs-Lehrgang **Kommunikation/Führung**

## Fernmeldeeinsatz

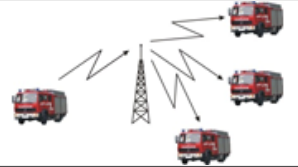

Landkreis Unterallgäu  
Kreisbrandinspektion

Fachbereich  
EDV, Funk und  
Kommunikation



## Fernmeldeeinsatz



**Polizei-Dienstvorschrift PDV/DV 800**

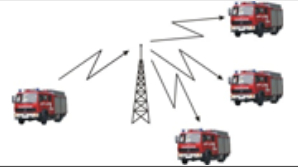

Landkreis Unterallgäu  
Kreisbrandinspektion

Fachbereich  
EDV, Funk und  
Kommunikation



Die PDV 800 / DV 800 „Fernmeldeeinsatz“ gilt für die Behörden und Organisationen mit Sicherheitsaufgaben (BOS) und legt die Grundsätze für den Fernmeldeeinsatz fest.

Sie beschreibt die einzelnen Fernmeldeverbindungen mit ihren Einsatzmöglichkeiten und Einsatzgrenzen.

Durch diese Vorschrift soll im Fernmeldedienst eine reibungslose Zusammenarbeit der Behörden und Organisationen mit Sicherheitsaufgaben sichergestellt werden.

Weiterführende landesspezifische Regelungen können für den Fernmeldeeinsatz bei der örtlichen und überörtlichen Gefahrenabwehr erfolgen.

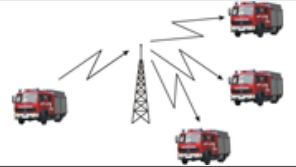

Landkreis Unterallgäu  
Kreisbrandinspektion

Fachbereich  
EDV, Funk und  
Kommunikation



# Zeichen und Symbole für Fernmeldeskizzen

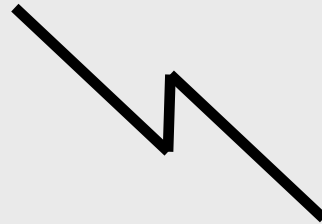

Bildliche Darstellung der  
Fernmeldeverbindungen

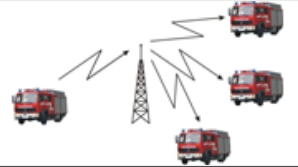

Landkreis Unterallgäu  
Kreisbrandinspektion

Fachbereich  
EDV, Funk und  
Kommunikation



geplante Verbindung



Funkbetrieb

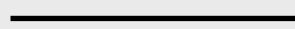

bestehende Verbindung



Relaisfunkbetrieb



Feldkabel



Lautsprecher



Bedienungszeichen



Mikrofon

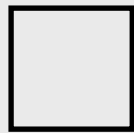

Fernmeldegerät

OB

Ortsbatteriebetrieb

ZB

Zentralbatteriebetrieb



Antenne

WB

Wählbetrieb

RS

Relaisschaltung



Landkreis Unterallgäu  
Kreisbrandinspektion

Fachbereich  
EDV, Funk und  
Kommunikation



## Beispiele



2-Meter-Funkverbindung auf Kanal 55 W/U



4-Meter-Funkverbindung Relaiskanal 471 G/U

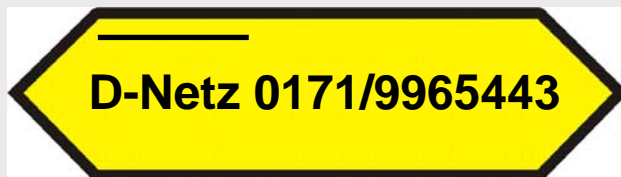

D-Netzanschluss mit Tel.-Nr. 0171/9965443



D-Netzanschluss FAX mit Tel.-Nr. 0171/9765843

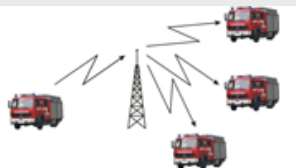

Landkreis Unterallgäu  
Kreisbrandinspektion

Fachbereich  
EDV, Funk und  
Kommunikation



## Funkkanäle

<b>K 471</b>	<b>Feuerwehr + THW</b> Unterallgäu und Memmingen	<b>55 W/U</b>	<b>Feuerwehr</b> Betriebskanal
<b>K 503</b>	<b>Katastrophenschutz</b> Unterallgäu und Memmingen	<b>55 W/O</b>	<b>Feuerwehr</b> PA + CSA
	<b>+ Ausweichkanal Feuerwehr</b>	<b>25 W/U</b>	<b>Feuerwehr</b> Ausweichkanal
		<b>25 W/O</b>	<b>Feuerwehr</b> Einsatzzentralen
		<b>31 W/U</b>	<b>Zusammenarbeit aller BOS</b>
		<b>34 W/U</b>	<b>Katastrophenschutz</b> Betriebskanal
		<b>42 W/U</b>	<b>Katastrophenschutz</b> Ausweichkanal
		<b>56 bG/U</b>	<b>Feuerwehr</b> Kohlbergtunnel A 96

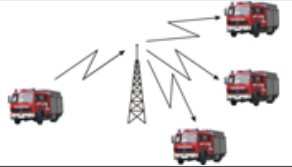

Landkreis Unterallgäu  
Kreisbrandinspektion

Fachbereich  
EDV, Funk und  
Kommunikation



## Kommunikationseinsatz

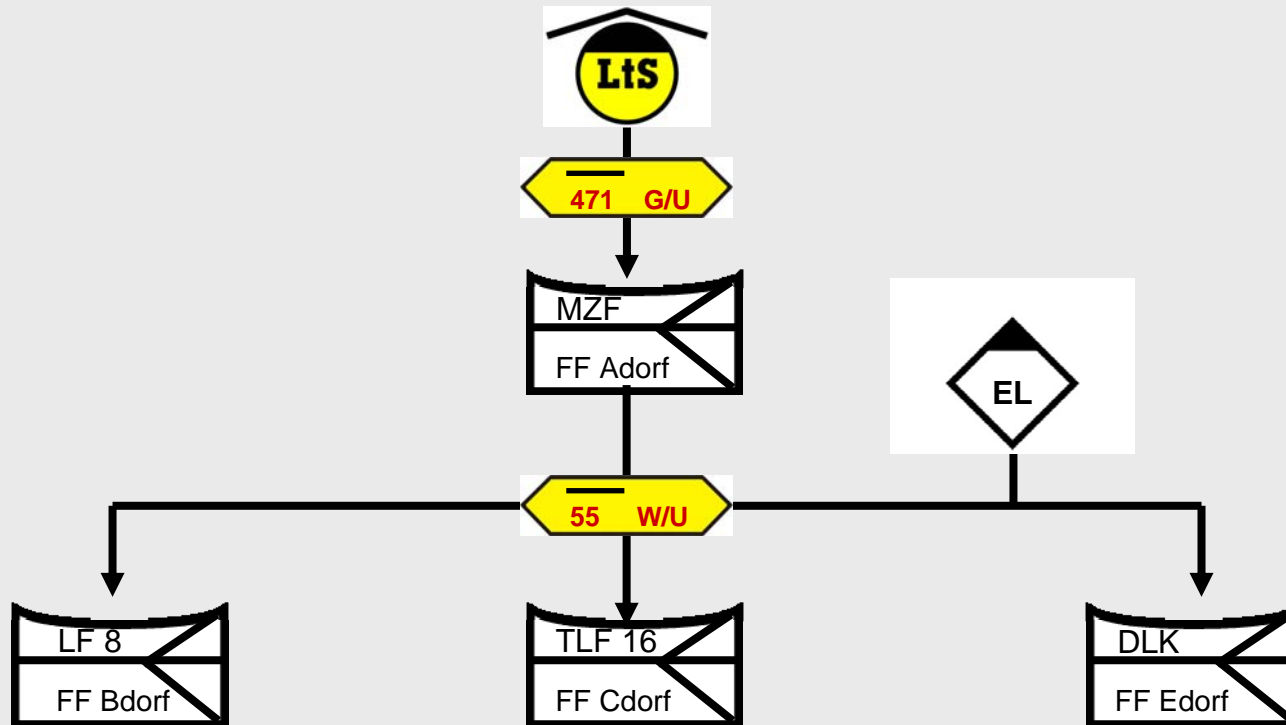



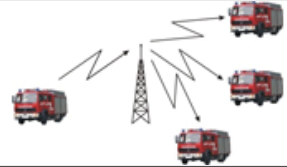

Landkreis Unterallgäu  
Kreisbrandinspektion

Fachbereich  
EDV, Funk und  
Kommunikation



## Kommunikationseinsatz

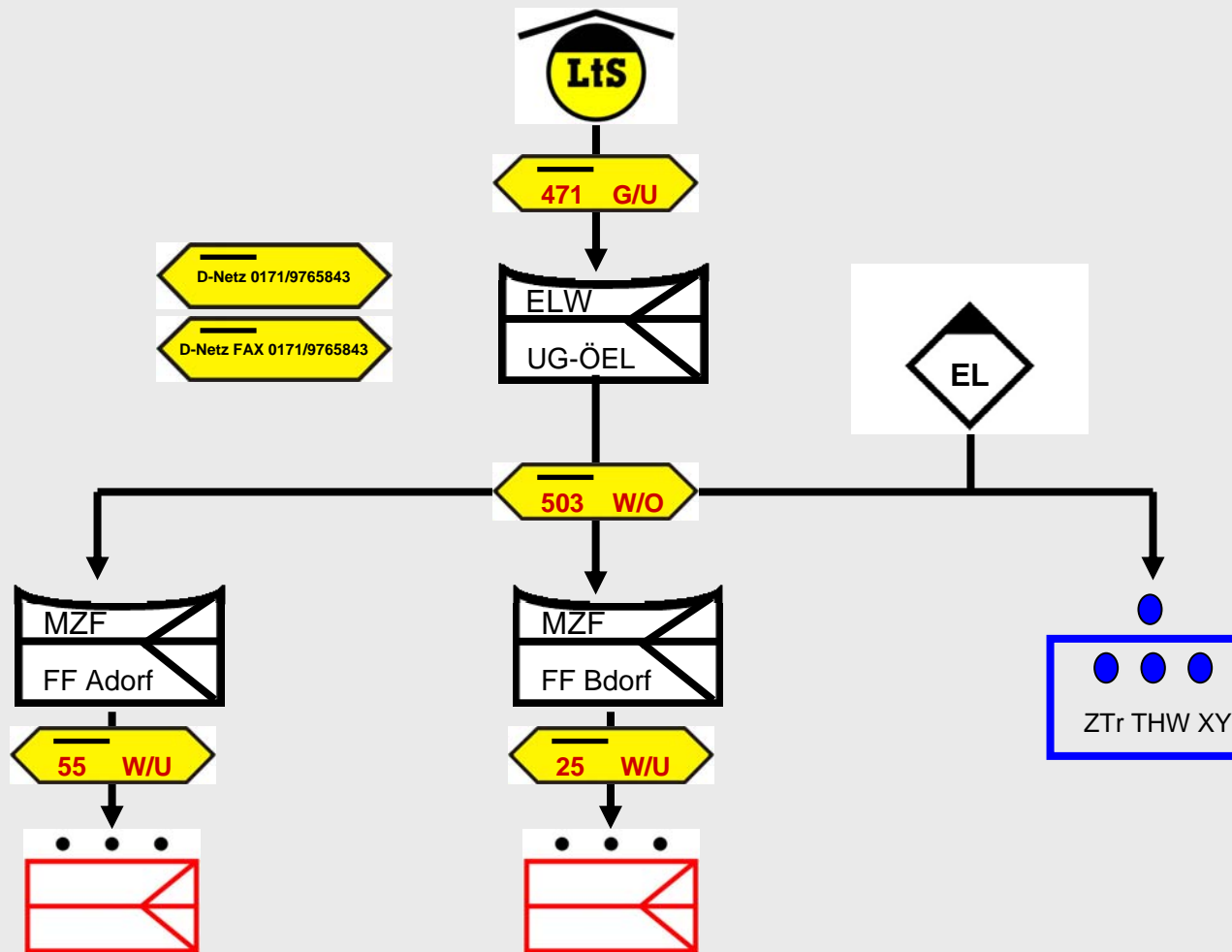

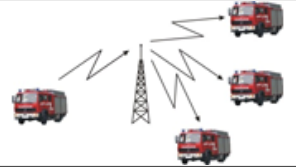

Landkreis Unterallgäu  
Kreisbrandinspektion

Fachbereich  
EDV, Funk und  
Kommunikation



**Noch Fragen?**